

QF4550CM1 - October 30, 2023

Item # QF4550CM1 was discontinued on October 30, 2023. For informational purposes, this is a copy of the website content at that time and is valid only for the stated product.

QUANTUM CASCADE LASERS: FABRY-PEROT, TWO-TAB C-MOUNT

- Center Wavelengths: 4.05 - 9.55 μm (2469 - 1047 cm^{-1})
- Output Powers up to 600 mW Ship from Stock
- Custom Options up to 2.5 W Available (Wavelength Dependent)
- Broadband Emission over a Roughly 50 cm^{-1} Range

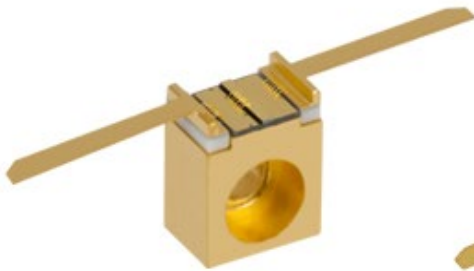

QF9550CM1
Quantum Cascade Laser

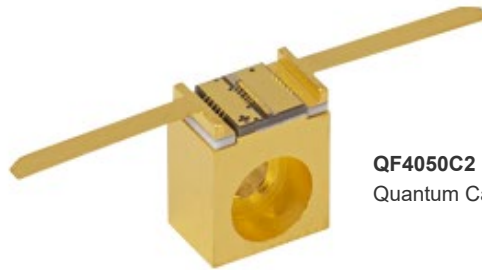

QF4050C2
Quantum Cascade Laser

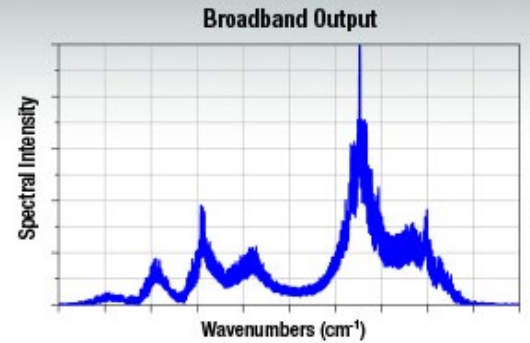

[Hide Overview](#)

OVERVIEW

Features

- Broadband Fabry-Perot Quantum Cascade Lasers (QCLs)
- CW Output Up to 600 mW (Custom Options Available Up to 2.5 W)
- Center Wavelengths Between 4.05 μm and 9.55 μm (2469 cm^{-1} and 1047 cm^{-1})
- Compact Two-Tab C-Mount Package: 6.4 mm x 4.3 mm x 7.9 mm (L x W x H)
- Lasers are Electrically Isolated from their C-Mounts
- Custom Wavelengths and Mounts Also Available (Contact Tech Support for Details)
- Gain Chips with AR-Coated Front Facets Also Available as a Custom Order

Thorlabs' Fabry-Perot Quantum Cascade Lasers (QCLs) exhibit broadband emission in a range spanning roughly 50 cm^{-1} . Each QCL's specified output power is the sum over the full spectral bandwidth. Since these lasers have broadband emission, they are well suited for medical imaging, illumination, and microscopy applications. Thorlabs also manufactures Distributed Feedback QCLs, which emit at a well defined center wavelength and are tunable over a narrow frequency range.

MIR Laser Types	
Fabry-Perot	TO Can
	Two-Tab C-Mount
	D-Mount
	HHL
	Turnkey
Distributed Feedback	Two-Tab C-Mount
	D-Mount
	HHL
	Turnkey

Laser Diode Selection Guide ^a
Shop by Package / Type
TO Can (Ø3.8, TO-46, Ø5.6, Ø9, and Ø9.5 mm)
TO Can Pigtail, Collimator Output (SM)
TO Can Pigtail (SM)
TO Can Pigtail (PM)
TO Can Pigtail (MM)
Fabry-Perot Butterfly Package
FBG-Stabilized Butterfly Package
VHG-Stabilized Butterfly Package (MM)
MIR Fabry-Perot QCL, TO Can
MIR Fabry-Perot QCL, Two-Tab C-Mount
MIR Fabry-Perot QCL, D-Mount
MIR Fabry-Perot QCL, High Heat Load
Chip on Submount
Single-Frequency Lasers
DFB TO Can Pigtail
DFB Butterfly Package
VHG-Stabilized TO Can
VHG-Stabilized TO Can Pigtail (SM)
VHG-Stabilized Butterfly Package

Before shipment, the output spectrum and L-I-V curve are measured for each serial-numbered device by an automated test station. These measurements are available below and are also included on a data sheet with the QCL. Each Fabry-Perot laser has an HR-coated back facet. As a custom option, our Fabry-Perot lasers can be ordered with an AR coating on the front facet; however, the custom item will operate as a gain chip and not as a CW laser. Though these QCLs are specified for CW output, they are compatible with pulsed applications. To order a Fabry-Perot QCL with a tested and specified pulsed optical power or other custom features, please contact Tech Support.

Packages

Each quantum cascade laser is mounted on a two-tab C-mount that provides high thermal conductivity and can be secured using a 2-56 or M2 screw with the counterbored Ø2.4 mm (Ø0.09") through hole. As measured from the bottom of the C-mount, the emission height of the QCLs is 7.15 mm or 7.39 mm, depending on the chosen QCL; the outer dimensions of the C-mounts are the same. Click on a laser's blue info icon (i) and view the Drawing tab to find the laser's emission height. All lasers sold on this page are electrically isolated from their C-mounts. Please see the *Handling* tab for more tips and information for handling these laser packages.

Mounts, Drivers, and Temperature Control

We generally recommend the LDMC20 C-Mount Laser Mount and ITC4002QCL or ITC4005QCL Dual Current / Temperature Controller for use with these QCLs. This device combination includes all the necessary components to mount, drive, and thermally regulate a two-tab C-mount laser. Other compatible current and temperature controllers are listed in the *Drivers* tab.

If designing your own mounting solution, note that due to these lasers' heat loads, we recommend that they be mounted in a thermally conductive housing to prevent heat buildup. Heat loads for Fabry-Perot QCLs can be up to 18 W (see the *Handling* tab for additional information).

The typical operating voltages of our QCLs are 7 - 16 V. These lasers do not have built-in monitor photodiodes and therefore cannot be operated in constant power mode.

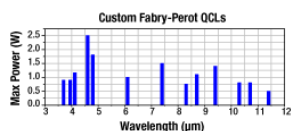

Maximum Output Power of Custom Fabry-Perot QCLs

High-Power OEM & Custom Lasers

Thorlabs manufactures custom and OEM quantum cascade lasers in high volumes. We maintain chip inventory from 3 µm to 12 µm at our Jessup, Maryland, laser manufacturing facility and can reach multi-watt output on certain custom orders.

More details are available on the *Custom & OEM Lasers* tab. To inquire about pricing and availability, please contact us. A semiconductor specialist will contact you within 24 hours or the next business day.

ECL Butterfly Package
 DBR Butterfly Package
 ULN Hybrid Extended Butterfly Package
 MIR DFB QCL, Two-Tab C-Mount
 MIR DFB QCL, D-Mount
 MIR DFB QCL, High Heat Load

Shop By Wavelength

a. Our complete selection of laser diodes is available on the *LD Selection Guide* tab above.

Webpage Features

	Clicking this icon opens a window that contains specifications and mechanical drawings.
	Clicking this icon allows you to download our standard support documentation.
Choose Item	Clicking the words "Choose Item" opens a drop-down list containing all of the in-stock lasers around the desired center wavelength. The red icon next to the serial number then allows you to download L-I-V and spectral measurements for that serial-numbered device.

[Hide Drivers](#)

DRIVERS

Current and Temperature Controllers

Use the tables below to select a compatible controller for our MIR lasers. The first table lists the controllers with which a particular MIR laser is compatible, and the second table contains selected information on each controller. Complete information on each controller is available in its full web presentation. We particularly recommend our ITC4002QCL and ITC4005QCL controllers, which have high compliance voltages of 17 V and 20 V, respectively. Together, these drivers support the current and voltage requirements of our entire line of Mid-IR Lasers. To get L-I-V and spectral measurements of a specific, serial-numbered device, click "Choose Item" next to the part number below, then click on the Docs Icon next to the serial number of the device.

Table Key

Current Controllers
Dual Current / Temperature Controllers

Laser Mount Compatibility

Thorlabs' LDMC20 C-Mount Laser Mount ships with current and TEC cables for the LDC4005, ITC4001, ITC4002QCL, ITC4005, and ITC4005QCL controllers. To use the LDMC20 with our other controllers, custom cables will be required. If designing your own mounting solution, note that due to these lasers' heat loads, we recommend that they be secured in a thermally conductive housing to prevent heat buildup. Heat loads for Fabry-Perot QCLs can be up to 18 W.

Laser and Controller Compatibility

Laser Item #	Wavelength	Current Controllers	Dual Current / Temperature Controllers
		Large Benchtop	Large Benchtop

QF4050C2	4.05 μm (2469 cm^{-1})	-	ITC4002QCL, ITC4005QCL
QF4550CM1	4.55 μm (2198 cm^{-1})	LDC4005	ITC4002QCL, ITC4005, ITC4005QCL
QF4600C2	4.60 μm (2174 cm^{-1})	-	ITC4002QCL, ITC4005QCL
QF8450C2	8.45 μm (1183 cm^{-1})	-	ITC4002QCL, ITC4005QCL
QF9150C2	9.15 μm (1093 cm^{-1})	-	ITC4002QCL, ITC4005QCL
QF9550CM1	9.55 μm (1047 cm^{-1})	LDC4005	ITC4002QCL, ITC4005, ITC4005QCL

Controller Selection Guide

Controller Item #	Controller Type	Controller Package	Current Range	Current Resolution	Voltage	Cables for LDMC20 Laser Mount
LDC210C	Current	Small Benchtop (146 x 66 x 290 mm)	0 to ± 1 A	100 μA	>10 V	Not Included with LDMC20 ^a
LDC240C			0 to ± 4 A	100 μA	>5 V	Not Included with LDMC20 ^a
LDC4005		Large Benchtop (263 x 122 x 307 mm)	0 to 5 A	1 mA (Front Panel) 80 μA (Remote Control)	12 V	Included with LDMC20
LDC8010		Rack Mounted	0 to ± 1 A	15 μA	>5 V	Not Included with LDMC20 ^a
LDC8020			0 to ± 2 A	30 μA	>5 V	Not Included with LDMC20 ^a
LDC8040			0 to ± 4 A	70 μA	>5 V	Not Included with LDMC20 ^a
ITC4001	Current / Temperature	Large Benchtop (263 x 122 x 307 mm)	0 to 1 A	100 μA (Front Panel) 16 μA (Remote Control)	11 V	Included with LDMC20
ITC4002QCL			0 to 2 A	100 μA (Front Panel) 32 μA (Remote Control)	17 V	Included with LDMC20
ITC4005			0 to 5 A	1 mA (Front Panel) 80 μA (Remote Control)	12 V	Included with LDMC20
ITC4005QCL		20 V			Included with LDMC20	
ITC8102		Rack Mounted	0 to ± 1 A	15 μA	>5 V	Not Included with LDMC20 ^a

a. Thorlabs does not currently offer cables that connect the LDMC20 mount to this controller. Custom cables will be required.

[Hide Handling](#)

H A N D L I N G

Handling Two-Tab C-Mount Lasers

Proper precautions must be taken when handling and using two-tab C-mount lasers. Otherwise, permanent damage to the device will occur. Members of our Tech Support staff are available to discuss possible operation issues.

Do

- ▶ Provide External Temperature Regulation (e.g., Heat Sinks, Fans, and/or Water Cooling)
- ▶ Use a Constant Current Source Specifically Designed for Lasers
- ▶ Observe Static Avoidance Practices
- ▶ Be Careful When Making Electrical Connections

Do Not

- ▶ Use Thermal Grease
- ▶ Expose the Laser to Smoke, Dust, Oils, Adhesive Films, or Flux Fumes
- ▶ Blow on the Laser
- ▶ Drop the Laser Package

Avoid Static

Since these lasers are sensitive to electrostatic shock, they should always be handled using standard static avoidance practices.

Avoid Dust and Other Particulates

Unlike TO can and butterfly packages, the laser chip of a two-tab C-mount laser is exposed to air; hence, there is no protection for the delicate laser chip. Contamination of the laser facets must be avoided. Do not blow on the laser or expose it to smoke, dust, oils, or adhesive films. The laser facet is particularly sensitive to dust accumulation. During standard operation, dust can burn onto this facet, which will lead to premature degradation of the laser. If operating a two-

tab C-mount laser for long periods of time outside a cleanroom, it should be sealed in a container to prevent dust accumulation.

Use a Current Source Specifically Designed for Lasers

These lasers should always be used with a high-quality constant current driver specifically designed for use with lasers, such as any current controller listed in the *Drivers* tab. Lab-grade power supplies will not provide the low current noise required for stable operation, nor will they prevent current spikes that result in immediate and permanent damage.

Thermally Regulate the Laser

Temperature regulation is required to operate the laser for any amount of time. The temperature regulation apparatus should be rated to dissipate the maximum heat load that can be drawn by the laser. For our quantum cascade lasers, it can be up to 18 W. The LDMC20 C-Mount Laser Mount, which is compatible with our two-tab C-mount lasers, is rated for >20 W of heat dissipation.

The back face of the C-mount package is machined flat to make proper thermal contact with a heat sink. Ideally, the heat sink will be actively regulated to ensure proper heat conduction. A Thermoelectric Cooler (TEC) is well suited for this task and can easily be incorporated into any standard PID controller.

A fan may serve to move the heat away from the TEC and prevent thermal runaway. However, the fan should not blow air on or at the laser itself. Water cooling methods may also be employed for temperature regulation. Do not use thermal grease with this package, as it can creep, eventually contaminating the laser facet. Pyrolytic graphite is an acceptable alternatives to thermal grease for these packages. Solder can also be used to thermally regulate two-tab C-mount lasers, although controlling the thermal resistance at the interface is important for best results.

For assistance in picking a suitable temperature controller for your application please contact Tech Support.

Carefully Make Electrical Connections

When making electrical connections, care must be taken. The flux fumes created by soldering can cause laser damage, so care must be taken to avoid this. Solder can be avoided entirely for two-tab C-mount lasers by using the LDMC20 C-Mount Laser Mount. If soldering to the tabs, solder with the C-mount already attached to a heat sink to avoid unnecessary heating of the laser chip.

Minimize Physical Handling

As any interaction with the package carries the risk of contamination and damage, any movement of the laser should be planned in advance and carefully carried out. It is important to avoid mechanical shocks. Dropping the laser package from any height can cause the unit to permanently fail.

[Hide Collimation](#)

COLLIMATION

Choosing a Collimating Lens

Since the output of our MIR lasers is highly divergent, collimating optics are necessary. Aspheric lenses, which are corrected for spherical aberration, are commonly chosen when the desired beam diameter is between 1 - 5 mm. The simple example below illustrates the key specifications to consider when choosing the correct lens for a given application.

The following example uses our previous generation 3.8 μm Interband Cascade Laser.

Key Specifications

- Center Wavelength: 3.80 μm
- Parallel Beam Divergence Angle: 40°
- Perpendicular Beam Divergence Angle: 60°
- Desired Collimated Beam Diameter: 4 mm (Major Axis)

The specifications for the IF3800CM2 indicate that the typical parallel and perpendicular FWHM divergences are 40° and 60°, respectively. Therefore, as the light propagates, an elliptical beam will result. To collect as much light as possible during the collimation process, consider the larger of these two divergence angles in your calculations (in this case, 60°).

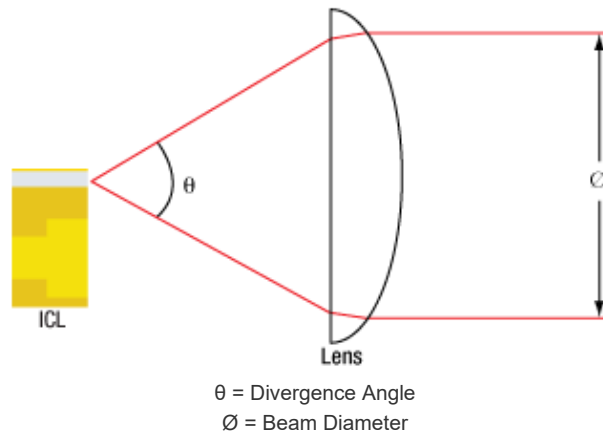

Using the information above, the focal length needed to obtain the desired beam diameter can be calculated:

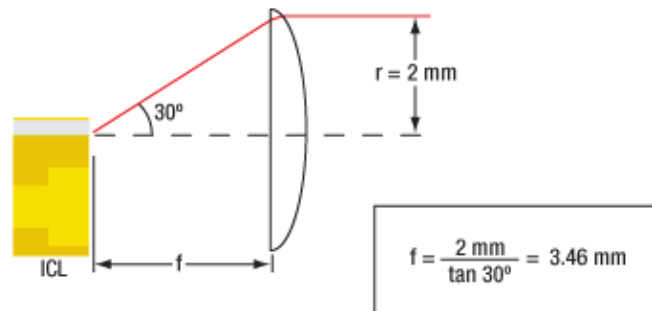

This information allows the appropriate collimating lens to be selected. Thorlabs offers a large selection of black diamond aspheric lenses for the mid-IR spectral range. Since this laser emits at $3.80 \mu\text{m}$, the best AR coating is our -E coating, which provides $R_{\text{avg}} < 0.6\%$ per surface from 3 to 5 μm . The lenses with focal lengths closest to the calculated value of 3.46 mm are our 390036-E (unmounted) or C036TME-E (mounted) Molded Aspheric Lenses, which have $f = 4.00 \text{ mm}$. Plugging this focal length back into the equation shown above gives a final beam diameter of 4.62 mm along the major axis.

Next, we verify that the numerical aperture (NA) of the lens is larger than the NA of the laser:

$$NA_{\text{Lens}} = 0.56$$

$$NA_{\text{Laser}} \sim \sin(30^\circ) = 0.5$$

$$NA_{\text{Lens}} > NA_{\text{Laser}}$$

Since $NA_{\text{Lens}} > NA_{\text{Laser}}$, the 390036-E or C036TME-E lenses will give acceptable beam quality. However, by using the FWHM beam diameter, we have not accounted for a significant fraction of the beam power. A better practice is to use the $1/e^2$ beam diameter. For a Gaussian beam profile, the $1/e^2$ beam diameter is approximately equal to 1.7X the FWHM diameter. The $1/e^2$ beam diameter is therefore a more conservative estimate of the beam size, containing more of the laser's intensity. Using this value significantly reduces far-field diffraction (since less of the incident light is clipped) and increases the power delivered after the lens.

A good rule of thumb is to pick a lens with an NA of twice the NA of the laser diode. For example, either the 390037-E or the C037TME-E could be used as these lenses each have an NA of 0.85, which is a little less than twice that of our IF3800CM2 laser (NA 0.5). Compared to the first set of lenses we identified, these have a shorter focal length of 1.873 mm, resulting in a smaller final beam diameter of 2.16 mm.

[Hide M² Measurement](#)

M² MEASUREMENT

Beam Profile Characterization of a Mid-IR Laser

Because quantum cascade lasers (QCLs) and interband cascade lasers (ICLs) have intrinsically large divergence angles, it is necessary to install collimating optics in front of the laser face, as shown in the *Collimation* tab. We are frequently asked what beam quality can be reasonably expected once the beam has been collimated. This tab presents an M^2 measurement we performed using our previous generation 3.80 μm Interband Cascade Laser.

For this system, we obtained $M^2 = 1.2 \pm 0.08$ in the parallel direction and $M^2 = 1.3 \pm 0.2$ in the perpendicular direction. While this is just one example, we believe these results to be representative of well-collimated mid-IR lasers manufactured by Thorlabs, as corroborated by supplementary measurements we have performed in-house.

Experimental Setup

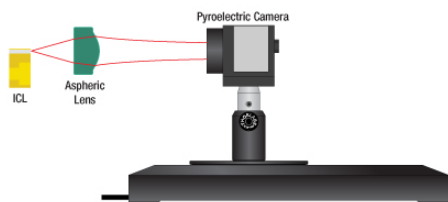

Pyroelectric Camera Upstream of Focus

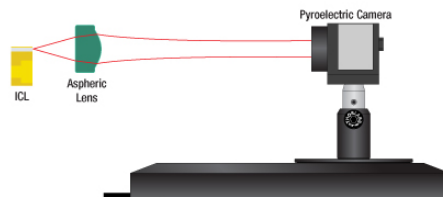

Pyroelectric Camera Downstream of Focus

The apparatus we used to determine M^2 is shown schematically in the figure above. In order to ensure that our results were rigorous, all data acquisition and analysis were consistent with the ISO11146 standard.

The IF3800CM2 Interband Cascade Laser used for this measurement emitted CW laser light with a center wavelength of 3.781 μm . Our LDMC20 temperature-stabilized mount held the laser's temperature at 25 $^{\circ}\text{C}$. The output beam was collimated by a C037TME-E lens located immediately downstream of the laser face. This lens was selected because of its large NA of 0.85 (which helped maximize collection of the emitted light) and because of its AR coating ($R_{\text{avg}} < 0.6\%$ per surface from 3 μm to 5 μm). We measured 10 mW of output power after the lens.

A pyroelectric camera (Spiricon Pyrocam IV) with 80 μm square pixels was scanned along the beam propagation direction, and the beam width was measured along the parallel and perpendicular directions using the second-order moment ($D4\sigma$) definition. Hyperbolas were fit to the beam width to extract M^2 for each direction. The camera's internal chopper was triggered at 50 Hz since the pyroelectric effect is sensitive to changes in temperature rather than absolute temperature differences. A ZnSe window was present in front of the detector array to help minimize visible light contributions to the signal.

Data Analysis

Presented to the right are the second-order moment ($D4\sigma$) beam widths for the parallel and perpendicular directions as a function of distance from the laser face (denoted as z). Along the parallel direction, we obtained a minimum beam width of 1.5 mm, while along the perpendicular direction, we obtained a minimum beam width of 1.3 mm. The spatial profiles we observed at the two minimum beam width positions, as obtained by the pyroelectric camera, are shown below.

The divergence of the beam can be described by a hyperbola, as written in Equation 1:

$$D4\sigma(z) = \sqrt{a + bz + cz^2} \quad (\text{Eq. 1})$$

In order to obtain the hyperbola coefficients a , b , and c for the parallel and perpendicular directions, we fit the discrete beam width measurements along each direction to hyperbolas, as shown in the graph to the right. These coefficients were substituted into Equation 2 (taking $\lambda = 3.781 \mu\text{m}$) to yield M^2 .

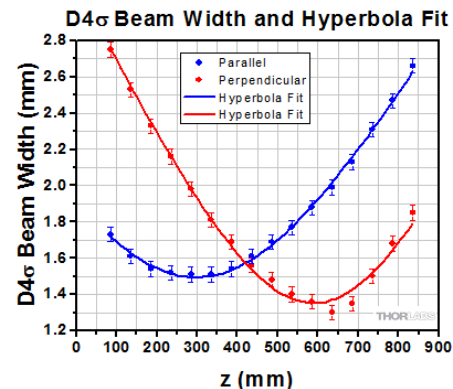

$D4\sigma$ Beam Width of Collimated IF3800CM2 Laser

$$M^2 = \frac{\pi}{8\lambda} \sqrt{4ac - b^2} \quad (\text{Eq. 2})$$

The hyperbola coefficients and M^2 values derived by this method are listed in the table below.

Value	Parallel	Perpendicular
a	$3.6 \pm 0.1 \text{ mm}^2$	$9.7 \pm 0.2 \text{ mm}^2$
b	$-0.0096 \pm 0.0007 \text{ mm}$	$-0.0268 \pm 0.0008 \text{ mm}$
c	$(1.61 \pm 0.08) \times 10^{-5}$	$(2.27 \pm 0.08) \times 10^{-5}$
M^2	1.2 ± 0.08	1.3 ± 0.2

The 0.85 NA of the collimating lens we used is the largest NA of any lens for this wavelength range that is offered in our catalog. Despite this large NA, we observed lobes in the far field (shown by the figure below) that are consistent with clipping of the laser-emitted light. An ideal measurement would not contain these artifacts.

As shown by the graph above and to the right, we observed significant astigmatism in the collimated beam: the beam waist of the parallel direction occurred around $z = 300 \text{ mm}$, while the beam waist of the perpendicular direction occurred around $z = 600 \text{ mm}$. This astigmatism corresponds closely to what is expected for this laser, given that the IF3800CM2 laser is specified with a parallel FWHM beam divergence of 40° and a perpendicular FWHM beam divergence of 60° .

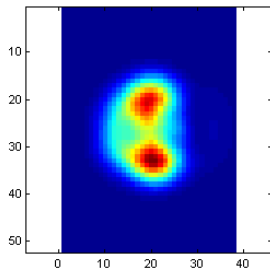

Beam Profile at Beam Waist of Parallel Direction
(Each Pixel is $80 \mu\text{m}$ Square)

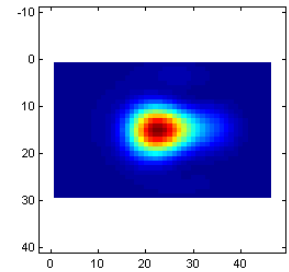

Beam Profile at Beam Waist of Perpendicular Direction
(Each Pixel is $80 \mu\text{m}$ Square)

[Hide Custom & OEM Lasers](#)

CUSTOM & OEM LASERS

Custom & OEM Quantum Cascade and Interband Cascade Lasers

At our semiconductor manufacturing facility in Jessup, Maryland, we build fully packaged mid-IR lasers and gain chips. Our engineering team performs in-house epitaxial growth, wafer fabrication, and laser packaging. We maintain chip inventory from $3 \mu\text{m}$ to $12 \mu\text{m}$, and our vertically integrated facilities are well equipped to fulfill unique requests.



Wire Bonding a Quantum Cascade Laser on a C-Mount

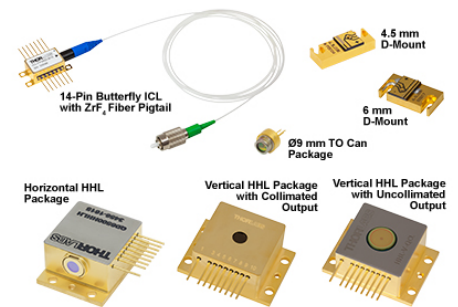

Some of Our Available Packages

High-Power Fabry-Perot QCLs

For Fabry-Perot lasers, we can reach multi-watt output power on certain custom orders. The available power depends upon several factors, including the wavelength and the desired package.

DFB QCLs at Custom Wavelengths

For distributed feedback (DFB) lasers, we can deliver a wide range of center wavelengths with user-defined wavelength precision. Our semiconductor specialists will take your application requirements into account when discussing the options with you.

The graphs below and photos to the right illustrate some of our custom capabilities. Please visit our semiconductor manufacturing capabilities presentation to learn more.

Contact Us

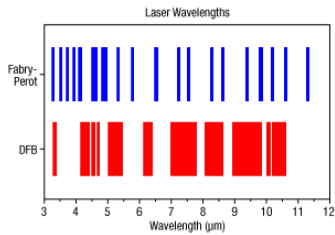

Available Wavelengths for Custom QCLs and ICLs

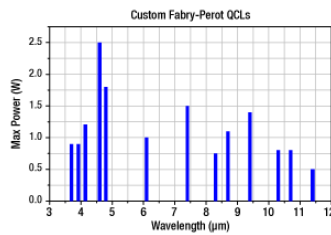

Maximum Output Power of Custom Fabry-Perot QCLs

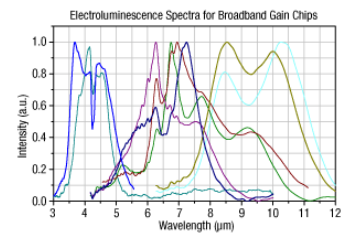

Electroluminescence Spectra of Available Gain Chip Material

[Hide Insights](#)

INSIGHTS

Insights into QCLs and ICLs

Scroll down to read about:

- QCLs and ICLs: Operating Limits and Thermal Rollover

[Click here for more insights into lab practices and equipment.](#)



QCLs and ICLs: Operating Limits and Thermal Rollover

The light vs. driving current (L-I) curves measured for quantum and interband cascade Lasers (QCLs and ICLs) include a rollover region, which is enclosed by the red box in Figure 1.

The rollover region includes the peak output power of the laser, which corresponds to a driving current of just under 500 mA in this example. Applying higher drive currents risks damaging the laser.

Laser Operation

These lasers operate by forcing electrons down a controlled series of energy steps, which are created by the laser's semiconductor layer structure and an applied bias voltage. The driving current supplies the electrons.

An electron must give up some of its energy to drop down to a lower energy level. When an electron descends one of the laser's energy steps, the electron loses energy in the form of a photon. But, the electron can also lose energy by giving it to the semiconductor material as heat, instead of emitting a photon.

Heat Build Up

Lasers are not 100% efficient in forcing electrons to surrender their energy in the form of photons. The electrons that lose their energy as heat cause the temperature of the lasing region to increase.

Conversely, heat in the lasing region can be absorbed by electrons. This boost in energy can scatter electrons away from the path leading down the laser's energy steps. Later, scattered electrons typically lose energy as heat, instead of as photons.

As the temperature of the lasing region increases, more electrons are scattered, and a smaller fraction of them produce light instead of heat. Rising temperatures can also result in changes to the laser's energy levels that make it harder for electrons to emit photons. These processes work together to increase the temperature of the lasing region and to decrease the efficiency with which the laser converts current to laser light.

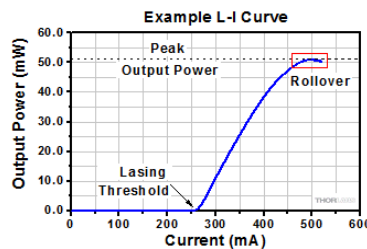

Figure 1: This example of an L-I curve for a QCL laser illustrates the typical non-linear slope and rollover region exhibited by QCL and ICL lasers. Operating parameters determine the heat load carried by the lasing region, which influences the peak output power. This laser was installed in a temperature controlled mount set to 25 °C.

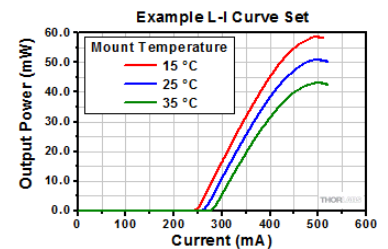

Figure 2: This set of L-I curves for a QCL laser illustrates that the mount temperature can affect the peak operating temperature, but that using a temperature controlled mount does not remove the danger of applying a driving current large enough to exceed the rollover point and risk damaging the laser.

Operating Limits are Determined by the Heat Load

Ideally, the slope of the L-I curve would be linear above the threshold current, which is around 270 mA in Figure 1. Instead, the slope decreases as the driving current increases, which is due to the effects from the rising temperature of the lasing region. Rollover occurs when the laser is no longer effective in converting additional current to laser light. Instead, the extra driving creates only heat. When the current is high enough, the strong localized heating of the laser region will cause the laser to fail.



A temperature controlled mount is typically necessary to help manage the temperature of the lasing region. But, since the thermal conductivity of the semiconductor material is not high, heat can still build up in the lasing region. As illustrated in Figure 2, the mount temperature affects the peak optical output power but does not prevent rollover.

The maximum drive current and the maximum optical output power of QCLs and ICLs depend on the operating conditions, since these determine the heat load of the lasing region.

Date of Last Edit: Dec. 4, 2019

[Hide 4.05 - 4.60 \$\mu\text{m}\$ Center Wavelength Fabry-Perot QCLs](#)

4.05 - 4.60 μm Center Wavelength Fabry-Perot QCLs

Item #	Info	Center Wavelength ^a	Power	Typical/Max Operating Current	Wavelength Tested	Laser Mode
QF4050C2		4.05 μm (2469 cm^{-1})	300 mW	400 mA / 500 mA	Yes	Single Transverse Mode
QF4550CM1 ^b		4.55 μm (2198 cm^{-1})	450 mW	900 mA / 1100 mA	Yes	
QF4600C2		4.60 μm (2174 cm^{-1})	600 mW	600 mA / 800 mA	Yes	

- a. These quantum cascade lasers exhibit broadband emission. The center wavelength is defined as a weighted average over all the modes. Each device has a unique spectrum. To get the spectrum of a specific, serial-numbered device, click "Choose Item" below, then click on the Docs Icon next to the serial number of the device. If you need spectral characteristics different than those shown below, please contact Tech Support to request a custom laser.
- b. If emission at a single wavelength is preferred, please consider our 4.00 - 5.00 μm Distributed Feedback Lasers.

Part Number	Description	Price	Availability
QF4050C2	Fabry-Perot Quantum Cascade Laser, 4.05 μm CWL, 300 mW, Two-Tab C-Mount	\$4,866.75	Today
QF4050C2	Center Wavelength: 3.94 μm , 300 mW (349 mA), 25 °C	\$4,866.75	Today
QF4050C2	Center Wavelength: 3.96 μm , 300 mW (360 mA), 25 °C	\$4,866.75	Today
QF4050C2	Center Wavelength: 3.95 μm , 300 mW (344 mA), 25 °C	\$4,866.75	Today
QF4050C2	Center Wavelength: 3.95 μm , 300 mW (363 mA), 25 °C	\$4,866.75	Today
QF4050C2	Center Wavelength: 3.95 μm , 300 mW (351 mA), 25 °C	\$4,866.75	Today
QF4050C2	Center Wavelength: 3.95 μm , 300 mW (351 mA), 25 °C	\$4,866.75	Today
QF4550CM1	Fabry-Perot Quantum Cascade Laser, 4.55 μm CWL, 450 mW, Two-Tab C-Mount	\$4,988.42	Lead Time
QF4600C2	Fabry-Perot Quantum Cascade Laser, 4.60 μm CWL, 600 mW, Two-Tab C-Mount	\$4,866.75	Today
QF4600C2	Center Wavelength: 4.55 μm , 600 mW (621 mA), 25 °C	\$4,866.75	Today
QF4600C2	Center Wavelength: 4.55 μm , 600 mW (630 mA), 25 °C	\$4,866.75	7-10 Days
QF4600C2	Center Wavelength: 4.56 μm , 600 mW (537 mA), 25 °C	\$4,866.75	Today

[Hide 8.45 \$\mu\text{m}\$ Center Wavelength Fabry-Perot QCL](#)

8.45 μm Center Wavelength Fabry-Perot QCL

Item #	Info	Center Wavelength ^a	Power	Typical/Max Operating Current	Wavelength Tested	Laser Mode
QF8450C2		8.45 μm (1183 cm^{-1})	300 mW	750 mA / 1000 mA	Yes	Single Transverse Mode



- a. These quantum cascade lasers exhibit broadband emission. The center wavelength is defined as a weighted average over all the modes. Each device has a

unique spectrum. To get the spectrum of a specific, serial-numbered device, click "Choose Item" below, then click on the Docs Icon next to the serial number of the device. If you need spectral characteristics different than those shown below, please contact Tech Support to request a custom laser.

Part Number	Description	Price	Availability
QF8450C2	Fabry-Perot Quantum Cascade Laser, 8.45 μm CWL, 300 mW, Two-Tab C-Mount	\$4,866.75	Today
QF8450C2	Center Wavelength: 8.39 μm , 300 mW (700 mA), 25 $^{\circ}\text{C}$	\$4,866.75	7-10 Days
QF8450C2	Center Wavelength: 8.42 μm , 300 mW (818 mA), 25 $^{\circ}\text{C}$	\$4,866.75	7-10 Days
QF8450C2	Center Wavelength: 8.49 μm , 300 mW (929 mA), 25 $^{\circ}\text{C}$	\$4,866.75	Today

[Hide 9.15 - 9.55 \$\mu\text{m}\$ Center Wavelength Fabry-Perot QCL](#)

9.15 - 9.55 μm Center Wavelength Fabry-Perot QCL

Item #	Info	Center Wavelength ^a	Power	Typical/Max Operating Current	Wavelength Tested	Laser Mode
QF9150C2		9.15 μm (1093 cm^{-1})	200 mW	850 mA / 1100 mA	Yes	Single Transverse Mode
QF9550CM1 ^b		9.55 μm (1047 cm^{-1})	80 mW	1500 mA / 1700 mA		

- a. This quantum cascade laser exhibits broadband emission. The center wavelength is defined as a weighted average over all the modes. Each device has a unique spectrum. To get the spectrum of a specific, serial-numbered device, click "Choose Item" below, then click on the Docs Icon next to the serial number of the device. If you need spectral characteristics different than those shown below, please contact Tech Support to request a custom laser.
- b. If emission at a single wavelength is preferred, please consider our 9.00 - 10.00 μm Distributed Feedback Lasers.

Part Number	Description	Price	Availability
QF9150C2	Fabry-Perot Quantum Cascade Laser, 9.15 μm CWL, 200 mW, Two-Tab C-Mount	\$4,866.75	Today
QF9150C2	Center Wavelength: 9.22 μm , 200 mW (914 mA), 25 $^{\circ}\text{C}$	\$4,866.75	Today
QF9150C2	Center Wavelength: 9.24 μm , 200 mW (925 mA), 25 $^{\circ}\text{C}$	\$4,866.75	Today
QF9150C2	Center Wavelength: 9.22 μm , 200 mW (920 mA), 25 $^{\circ}\text{C}$	\$4,866.75	Today
QF9550CM1	Fabry-Perot Quantum Cascade Laser, 9.55 μm CWL, 80 mW, Two-Tab C-Mount	\$5,576.58	Today
QF9550CM1	Center Wavelength: 9.69 μm , 80 mW, (1481 mA), 25 $^{\circ}\text{C}$	\$5,576.58	Today

Optical Electrical Characteristics (T_{CASE} = 25 °C, P = 450 mW)

Characteristic	Min	Typ.	Max	Unit
Center Wavelength	4.45	4.55	4.65	μm
Spectral Bandwidth (5% - 95% Integrated Power)	-	130	-	nm
Optical Output Power	450	-	-	mW
Beam Divergence (FWHM) - Perpendicular	-	55	-	deg.
Beam Divergence (FWHM) - Parallel	-	30	-	deg.
Forward Voltage	-	10.5	12.0	V
Operating Current	-	900	1100	mA
Threshold Current	-	600	-	mA
Slope Efficiency	-	1.2	-	W/A

Absolute Maximum Ratings^a (T_{CASE} = 25 °C)

Characteristic	Value	Unit
Optical Output Power (CW)	500	mW
LD Reverse Voltage	1	V
Operating Current	1100	mA
Operating Temperature ^b	15 to 30	°C
Storage Temperature ^b	-40 to 85	°C

- a. These lasers have not been extensively tested beyond the values shown in this table. Device damage may occur if these values are exceeded.
b. Non-condensing environment.

General Specifications^a

Characteristic	Value
Laser Mode	Single Transverse Mode
Wavelength Tested	Yes

- a. If emission at a single wavelength is preferred, please consider our [4.00 - 5.00 μm Distributed Feedback Lasers](#).

Sample QF4550CM1 Output Spectrum

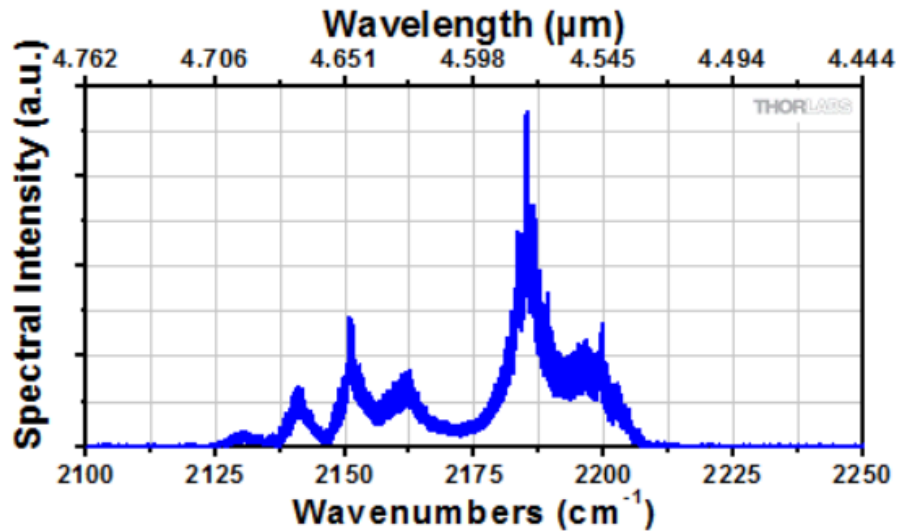

All values are measured at 25 °C. To view an Excel file that lists all of the measured spectral and L-I-V characteristic values of the sample QCL shown above, please click [here](#). Serial-number-specific documentation is available by clicking "Choose Item" on the left side of the price box.

The spectrum above shows the fine structure of the Fabry-Perot modes, which can be seen in the raw data file. Please note that the resolution bandwidth of this measurement is 0.125 cm⁻¹ (3.75 GHz).

Sample QF4550CM1 L-I-V Characteristics

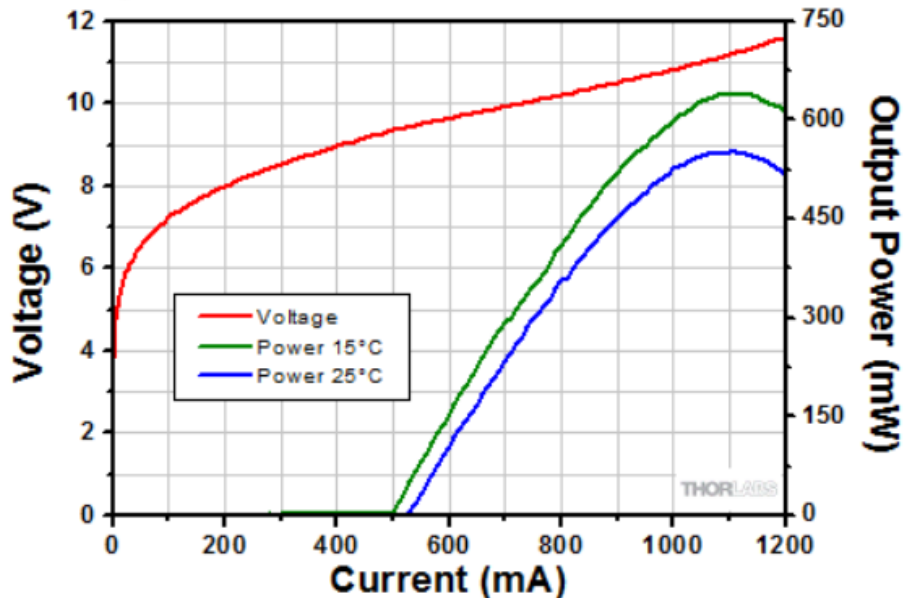

All values are measured at 25 °C, unless otherwise indicated. To view an Excel file that lists all of the measured spectral and L-I-V characteristic values of the sample QCL shown above, please click [here](#). Serial-number-specific documentation is available by clicking "Choose Item" on the left side of the price box.

Sample QF4550CM1 Far Field Divergence

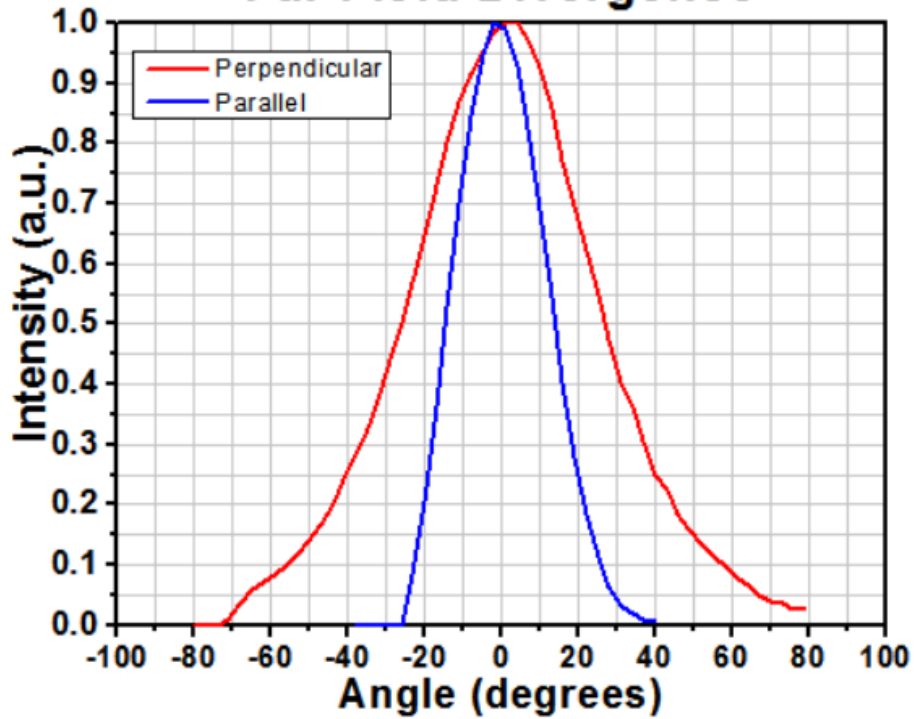

All values are measured at 25 °C. To view an Excel file that lists all of the measured spectral, L-I-V, and far field characteristic values of the sample ICL shown above, please click [here](#). Serial-number-specific documentation is available by clicking "Choose Item" on the left side of the price box.

Far field divergence values are measured at 25 °C and at a distance of 89.4 mm from the laser. The detector's aperture is Ø10 mm, and the sampling step size is 3°. The angle subtended by the detector is 6.4°.

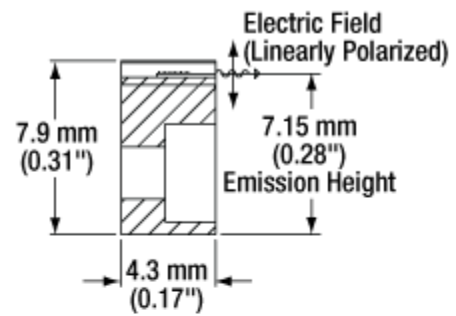
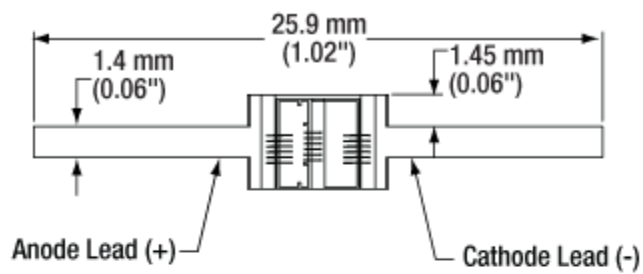

Section A-A

